



RACCORDI IN GHISA ZINCATI MICROFUSI

NIPPLO CONICO	Cod.	DN
	GHISA ZINCATI	
	Z00W090050001	1/2"
	Z00W090050002	3/4"
	Z00W090050003	1"
	Z00W090050004	1"1/4"
	Z00W090050005	1"1/2"
	Z00W090050006	2"
	Z00W090050007	2"1/2"
	Z00W090050008	3"
	Z00W090050009	4"

NIPPLO CONICO DI RIDUZIONE	Cod.	DN
	GHISA ZINCATI	
	Z00W0900500101	3/4" 3/8"
	Z00W0900500102	3/4" 1/2"
	Z00W0900500103	1" 1/2"
	Z00W0900500104	1" 3/4"
	Z00W0900500105	1"1/2" 1"
	Z00W0900500106	2" 1"
	Z00W0900500107	2" 1"1/2"
	Z00W0900500108	2"1/2" 2"
	Z00W0900500109	3" 2"
Z00W0900500110	3" 2"1/2"	

MANICOTTO	Cod.	DN
	GHISA ZINCATI	
	Z00W0900500201	1/2"
	Z00W0900500202	3/4"
	Z00W0900500203	1"
	Z00W0900500204	1"1/4"
	Z00W0900500205	1"1/2"
	Z00W0900500206	2"
	Z00W0900500207	2"1/2"
	Z00W0900500208	3"
	Z00W0900500209	4"

MANICOTTO DI RIDUZIONE

Cod. DN



GHISA ZINCATI		
Z00W0900500301	3/4"	3/8"
Z00W0900500302	3/4"	1/2"
Z00W0900500303	1"	1/2"
Z00W0900500304	1"	3/4"
Z00W0900500305	1"1/2"	1"
Z00W0900500306	2"	1"
Z00W0900500307	2"	1"1/2"

RIDUZIONE CONICA M/F

Cod. DN



GHISA ZINCATI		
Z00W0900500401	3/4"	3/8"
Z00W0900500402	3/4"	1/2"
Z00W0900500403	1"	1/2"
Z00W0900500404	1"	3/4"
Z00W0900500405	1"1/4"	3/4"
Z00W0900500406	1"1/4"	1"
Z00W0900500407	1"1/2"	1"
Z00W0900500408	1"1/2"	1"1/4"
Z00W0900500409	2"	1"
Z00W0900500410	2"	1"1/4"
Z00W0900500411	2"	1"1/2"
Z00W0900500412	2"1/2"	1"1/2"
Z00W0900500413	2"1/2"	2"
Z00W0900500414	3"	2"
Z00W0900500415	4"	2"
Z00W0900500416	4"	3"

TAPPO CONICO

Cod. DN



GHISA ZINCATI	
Z00W0900500501	1/2"
Z00W0900500502	3/4"
Z00W0900500503	1"
Z00W0900500504	1"1/4"
Z00W0900500505	1"1/2"
Z00W0900500506	2"
Z00W0900500507	2"1/2"
Z00W0900500508	3"

GOMITO F/F	Cod.	DN
	GHISA ZINCATI	
	Z00W0900500601	1/2"
	Z00W0900500602	3/4"
	Z00W0900500603	1"
	Z00W0900500604	1"1/4"
	Z00W0900500605	1"1/2"
	Z00W0900500606	2"
	Z00W0900500607	2"1/2"
	Z00W0900500608	3"
	Z00W0900500609	4"

GOMITO M/F - SEDE CONICA	Cod.	DN
	GHISA ZINCATI	
	Z00W0900500701	1/2"
	Z00W0900500702	3/4"
	Z00W0900500703	1"
	Z00W0900500704	1"1/4"
	Z00W0900500705	1"1/2"
	Z00W0900500706	2"
	Z00W0900500707	2"1/2"
	Z00W0900500708	3"
	Z00W0900500709	4"

TI F/F/F	Cod.	DN
	GHISA ZINCATI	
	Z00W0900500801	1/2"
	Z00W0900500802	3/4"
	Z00W0900500803	1"
	Z00W0900500804	1"1/4"
	Z00W0900500805	1"1/2"
	Z00W0900500806	2"
	Z00W0900500807	2"1/2"
	Z00W0900500808	3"
	Z00W0900500809	4"

CROCE

Cod. DN



GHISA ZINCATI	
Z00W0900500901	1/2"
Z00W0900500902	3/4"
Z00W0900500903	1"
Z00W0900500904	1"1/4"
Z00W0900500905	1"1/2"
Z00W0900500906	2"
Z00W0900500907	2"1/2"
Z00W0900500908	3"

GIUNTO 3 PEZZI F/F GAS SEDE CONICA

Cod. DN



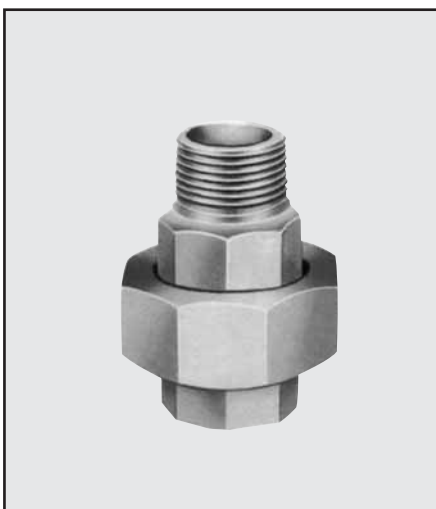

GHISA ZINCATI	
Z00W0900501002	3/8"
Z00W0900501003	1/2"
Z00W0900501004	3/4"
Z00W0900501005	1"
Z00W0900501006	1"1/4"
Z00W0900501007	1"1/2"
Z00W0900501008	2"
Z00W0900501009	2"1/2"

Cod. DN



GHISA ZINCATI	
Z00W0900501101	3/8"
Z00W0900501102	1/2"
Z00W0900501103	3/4"
Z00W0900501104	1"
Z00W0900501105	1"1/4"
Z00W0900501106	1"1/2"
Z00W0900501107	2"

TAPPO FEMMINA	Cod.	DN
	GHISA ZINCATI	
	Z00W0900501222	1/4"
	Z00W0900501223	3/8"
	Z00W0900501224	1/2"
	Z00W0900501225	3/4"
	Z00W0900501226	1"
	Z00W0900501227	1"1/4"
	Z00W0900501228	1"1/2"
	Z00W0900501229	2"
	Z00W0900501230	2"1/2"
	Z00W0900501231	3"
	Z00W0900501232	4"

PORTAGOMMA	Cod.	DN
	OTTONE	
	Z00W0900501321	1/8"
	Z00W0900501322	1/4"
	Z00W0900501323	3/8"
	Z00W0900501324	1/2"
	Z00W0900501325	3/4"
	Z00W0900501326	1"
	Z00W0900501327	1"1/4"
	Z00W0900501328	1"1/2"
	Z00W0900501329	2"
	Z00W0900501330	2"1/2"
	Z00W0900501331	3"
	Z00W0900501332	4"
	N.B. Specificare Ø mt del tubo al momento dell'ordine.	

TRONCHETTO A SALDARE	Cod.	DN
	ACCIAIO	
	Z00W0900501431	1/8"
	Z00W0900501432	1/4"
	Z00W0900501433	3/8"
	Z00W0900501434	1/2"
	Z00W0900501435	3/4"
	Z00W0900501436	1"
	Z00W0900501437	1"1/4"
	Z00W0900501438	1"1/2"
	Z00W0900501439	2"